**Field Guide
For
Erosion and Sediment Control
On Construction Sites
In
Alabama**

**Alabama Soil and Water
Conservation Committee
and
Partners**

Third Edition, December 2018

Preface

The purpose of this Field Guide is to provide a quick, handy guide for persons involved in land disturbing activities. This includes homebuilders, general contractors, road builders, installers of best management practices, erosion and sediment control planners and designers, plan reviewers and inspectors.

The basis for the Field Guide is Volume 2 of the Alabama Handbook for Erosion Control, Sediment Control and Stormwater Management on Construction Sites and Urban Areas, July 2018.

The Field Guide covers the most commonly used erosion and sediment control practices contained in the Alabama Handbook. Some details and most pictures of the practices were omitted to maintain a small format.

Consult the Alabama Handbook Volumes 1 and 2 for details on planning, design, construction and inspections. It may be viewed at the Alabama Soil and Water Conservation Committee homepage (<https://alconservationdistricts.gov>) under the “Resources – Erosion and Sediment Control” tab and it may be purchased from the Jefferson County Soil and Water Conservation Foundation (order form is at the same web location mentioned above).

This Field Guide may be obtained from the various project partners (see Acknowledgements section).

Acknowledgements

This Field Guide is a product of a partnership coordinated by the Alabama Soil and Water Conservation Committee. The partnering organizations are listed below:

Alabama Soil and Water Conservation Committee
Alabama Association of Conservation Districts
Alabama Department of Environmental Management
Alabama Department of Transportation
Associated General Contractors of Alabama
Auburn University
Alabama Cooperative Extension System
Home Builders Association of Alabama
Natural Resources Conservation Service
Soil and Water Conservation Society - Alabama Chapter

Appreciation is expressed to the following entities for their input in developing and revising the Field Guide:

Alabama Department of Environmental Management
Alabama Department of Transportation
Auburn University Erosion and Sediment Control Test Facility
Home Builders Association of Alabama
Natural Resources Conservation Service
Sunshine Supplies, Inc.
Thompson Engineering, Inc.
Volkert, Inc.

Table of Contents

Preface	i
Acknowledgements	ii
Table of Contents	iii
Chapter 1 Introduction	1
Chapter 2 Site Preparation Practices	7
Construction Exit Pad (CEP).....	9
Topsoiling (TSG)	11
Chapter 3 Surface Stabilization Practices	15
Chemical Stabilization (CHS).....	17
Dust Control (DC).....	19
Erosion Control Blanket (ECB)	21
Groundskeeping (GK)	23
Mulching (MU).....	27
Permanent Seeding (PS)	31
Sodding (SOD).....	37
Temporary Seeding (TS).....	43
Tree Planting on Disturbed Areas (TP).....	49
Chapter 4 Runoff Conveyance Practices	53
Check Dam (CD).....	55
Diversion (DV).....	63
Drop Structure (DS)	117
Grass Swale (GS)	65
Lined Swale (LS).....	67
Outlet Protection (OP).....	69
Riprap-Lined Swale (RS)	71
Temporary Slope Drains (TSD)	73
Chapter 5 Sediment Control Practices	77
Brush/Fabric Barrier (BFB).....	79
Flocculant (FL)	81
Inlet Protection (IP)	83
Rock Filter Dam (RD).....	91
Sediment Barrier (SB).....	95
Sediment Basin (SBN)	101 and 117
Sediment Trap (ST).....	105

Table of Contents (cont.)

Chapter 6 Stream Protection Practices	109
Temporary Stream Crossing (TSC)	111
Chapter 7 Earthen Dam Structures	115
Earthen Dam Structures.....	117
Contacts.....	121

Chapter 1

Introduction

This Page
Intentionally
Left Blank

Introduction

Use of the Field Guide

This Field Guide provides general guidance (descriptions and illustrations) for installing and maintaining many of the erosion and sediment control practices that are referred to as Best Management Practices (BMPs).

Detailed design plans/drawings are the basis for meeting requirements on most sites and the **plan design requirements take precedence over details in the Field Guide.**

Also, the Field Guide is **not intended to be used for specifications in instances where a design is not available. A professional should always be consulted.**

Benefits of Erosion and Sediment Control

The benefits of effective erosion and sediment control are important to the environment, to contractors and the public. Keeping sediment out of small conveyances, channels, streams, lakes and rivers contributes to clean water, protection of wetlands and reduces maintenance costs associated with culverts, road ditches and drainage channels. The biological integrity of streams and lakes is protected with effective erosion and sediment control. Contractor construction costs should be minimized with a well-executed erosion and sediment control program. Obviously, the public benefits as the environment is protected and construction costs are minimized. These benefits are

accomplished most effectively with proper installation and maintenance of BMPs.

Principles of Erosion and Sediment Control

- Emphasize erosion control to minimize soil detachment and sediment production.
- Minimize the periods of bare ground by shortening construction periods and staging a project (dividing the project into sectors that will be done independently of other sectors) when possible. Install practices in a sequence that supports shortened construction periods and permits the use of temporary and permanent seeding when the practices can be most effective.
- Use perimeter and interior sediment control and erosion control measures that minimize erosive velocities and minimize sediment transport off the disturbed site.
- Prevent sediment from leaving the construction site at entrance/exits during muddy periods.
- Use practices that minimize turbid water from leaving the construction site.
- Give special attention to cut-and-fill slopes because they are difficult to stabilize.
- Give special attention to sites that are transected by streams or are near streams and wetlands because close proximity to these areas increases the importance of effective erosion and sediment control.

- Maintain practices to ensure their effectiveness. This includes regular inspections of the practices, the site, adjacent off-site areas and receiving streams.
- A schedule of regular inspections should be set forth to ensure that repairs and maintenance receive appropriate attention.

Alabama 811 (call before you dig)

Determine exact location of underground utilities before beginning earthmoving or excavations. If you don't call and lines are cut, you may be billed for the repair. The number to call in Alabama is 811 or 1-800-292-8525. Check out www.al811.com for more information. Free downloads are available for iPhone and Android.

This Page
Intentionally
Left Blank

Chapter 2

Site Preparation

This Page
Intentionally
Left Blank

Construction Exit Pad (CEP)

Description

An aggregate pad that removes mud and caked soil from the tires of construction vehicles. It is located where traffic will be leaving a construction site and moving directly onto a public road or street.

Installation

- Begin by removing all vegetation and other unsuitable material from the foundation area.
- Grade and crown the area for positive drainage.
- Utilize a diversion to direct any surface flow away from the construction exit pad.
- Install pipe under the pad if needed to maintain drainage ditches along public roads.
- Divert all construction exit pad runoff and drainage to a sediment trap or basin.
- Place 8 oz. non-woven geotextile filter fabric on the graded foundation before placing the aggregate.
- Place specified aggregate size to lines and grade shown on plans. Leave smooth and sloped for drainage. If aggregate size is not specified, use ALDOT Coarse Aggregate No. 1 (most of the aggregate should be 2.5" – 3.5").
- If dimensions are not specified, pads are generally 50' x 20'. Adjustments in size should be made to accommodate site conditions.
- At home sites, the construction exit pad aggregate can often be subsequently used as a foundation for the concrete driveway.

Maintenance

- Remove large chunks of mud or caked soil from construction exit pad daily.
- Inspect aggregate pad and sediment disposal area weekly and after storm events or heavy use.
- Reshape pad as needed for drainage and runoff control.
- Top-dress with clean specified stone as needed to maintain effectiveness.
- Immediately remove mud or sediment tracked or washed onto public road by sweeping or manual removal (DO NOT wash material into nearby storm drains).
- Remove unneeded exit pad materials from areas where permanent vegetation will be established.

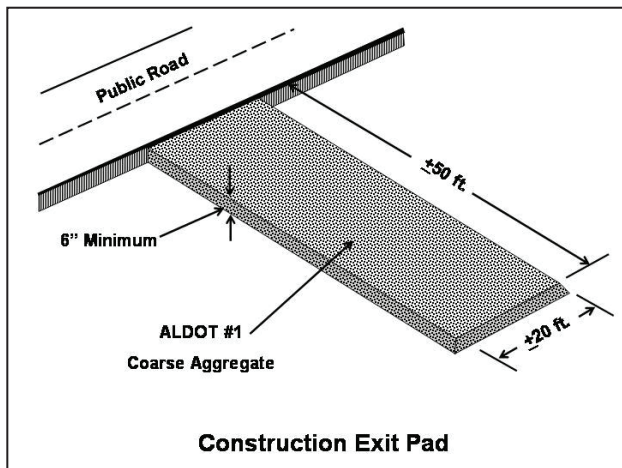

Figure CEP-1 Typical Construction Exit Pad.

Topsoiling (TSG)

Description

The removal of the desirable soil surface at a site prior to construction and using it on areas to be vegetated. Topsoiling a site usually improves the quality of the plant growth medium at the site and increases the likelihood of successful plant establishment and performance.

Installation

- Begin by identifying on the design plan the area to be stripped, the depth of soil to be removed, the storage area and the areas to utilize topsoil. If a plan is not available, obtain the aid of a qualified design professional.
- Schedule stripping to precede or be done concurrently with land grading.
- Install silt fence or other sediment barrier where necessary to minimize sediment movement from stockpile site.
- Remove and dispose of stumps, roots, trash, noxious weeds, and soils containing toxic chemicals according to locally accepted procedures and regulations.
- Stockpile topsoil at the site(s) identified in the plan or by the design professional.
- In the absence of plan details, locate the stockpile so that natural drainage is not obstructed and avoid stockpiling on steep slopes or near waterbodies, wetlands, or storm drain inlets.

- Side slopes of the stockpile should not exceed 2:1.
- Protect stockpile as specified in the design plan. In the absence of details in the plan, use temporary seeding as soon as possible and not more than 13 working days after formation of stockpile (see Temporary Seeding practice).
- Mulching may be substituted for temporary seeding on stockpiles that will be used within 2 months (see Mulching practice).
- If stockpiles will not be used within 12 months, they should be stabilized by permanent vegetation to control erosion and weed growth (see Permanent Seeding practice).
- Immediately prior to spreading topsoil for reuse, adjust the pH of the subsoil with lime if needed and loosen the subgrade of the site to receive the topsoil by disking or scarifying to a depth of at least 2” to ensure bonding of the topsoil and subsoil.
- Uniformly spread topsoil to the depth specified in the design plan, as specified by a qualified professional or to a minimum of 4”. For long-term growth of vegetation without irrigation, minimum soil depth (subsoil and topsoil) should be 8” to 12” over loose sand or rock fragments. Soil depth of 24” is needed over bedrock.
- Maintain grades shown in the construction plan.

Maintenance

- Inspect areas that received topsoil after rainstorms until vegetation is established.
- Repair eroded or damaged areas and revegetate.

- Repair sloughing on steep slopes by removing the topsoil, roughening the subgrade and resspreading topsoil.
- Consult with a qualified design professional if drainage (wetness caused by seepage) or shallowness to bedrock (less than 24”) is involved.



Figure TSG-1 Topsoil to be Spread.

This Page
Intentionally
Left Blank

Chapter 3

Surface Stabilization

This Page
Intentionally
Left Blank

Chemical Stabilization (CHS)

Description

The application of chemical products typically during temporary seeding or mulching operations to control erosion caused by water and wind. Water-soluble flocculant is often used for this.

Installation

- Prepare application site according to plans and specifications.
- Conduct site soil testing for products to verify performance with site soils before use.
- Obtain toxicity reports and OSHA Safety Data Sheets (SDSs) from the supplier before using products on site.
- All products should be mixed, applied, and equipment cleaned according to OSHA SDSs, and the manufacturer's recommendation. Rinse residue should be applied to soil areas needing stabilization.
- Runoff from the treated area should not be allowed to drain directly into storm drains or offsite prior to additional treatment options, such as directing to a sediment basin.
- Check for compliance with all manufacturer recommendations and safety requirements during application.

Maintenance

- Reapply products if treated areas are disturbed or tilled per the manufacturer recommendations.

- Maintain application equipment to ensure uniform applications.
- Remove downgradient sediment deposits as needed.
- Inspect monthly and after rain events.



Figure CHS-1 Hydraulically Applied Flocculant.

Photo courtesy of Sunshine Supplies, Inc.

Dust Control

Description

Controlling dust during land disturbing activities to minimize on-site and off-site damages and hazards.

Installation

- Sequence construction to minimize the amount of disturbed area at any one time.
- Leave undisturbed vegetative buffers between disturbed areas, if possible.
- Install planned surface stabilization measures immediately after completing grading.
 - Vegetative Cover – Apply according to plans and specifications.
 - Mulch – Apply according to plans and specifications.
- Sprinkling – Sprinkle disturbed areas with water until surface is moist. Repeat as often as needed to maintain moisture. Be careful not to overwater as to cause or contribute to stormwater runoff.
- Barriers – Install fences perpendicular to prevailing wind at intervals of 15 times the fence height.
- Calcium Chloride – Apply according to plans and specifications using a mechanical spreader.
- Spray-on Adhesives – Apply according to plans and specifications or the following table if not specified.
- Stone – Place proper gradation to the specified width and thickness.

Table DC-1 Application Rates for Spray-on Adhesives Used in Dust Control

Adhesive	Water Dilution (water: adhesive)	Type of Nozzle	Application Rate (gallons/acre)
Anionic Asphalt Emulsion	7:1	Coarse	1200
Latex Emulsion	12.5:1	Fine	235
Resin in Water	4:1	Fine	300

Source: Virginia Erosion and Sediment Control Handbook, 1993

Consult with a qualified design professional if spray-on adhesives are specified. A permit may be required.

Maintenance

- Prohibit traffic on treated surfaces until curing is complete.
- Check site during windy conditions to monitor measure effectiveness.
- Maintain dust control measures continuously throughout dry weather periods, until all disturbed areas have been stabilized.
- Ensure that any run off water is diverted to a BMP practice to be treated before discharge.

Erosion Control Blanket (ECB)

Description

Protective cover made of straw, jute, wood or other plant fibers; plastic, nylon, paper or cotton. Erosion control blanket is used on areas with high erosion potential such as steep slopes and channels to protect soil from raindrop impact and erosive velocities while facilitating vegetative growth.

Installation

- Grade the site to a smooth uniform surface, free of debris.
- Control any run-on water using diversion channels.
- Incorporate soil amendments and seed according to plans and specifications.
- Ensure blanket type meets plans and specifications.
- Blankets should be installed just beyond the top and bottom of the slope being treated.
- Install erosion control blankets according to manufacturer's recommendations; especially concerning blanket terminations, overlaps, and stapling patterns (lack of adequate stapling is often a cause of blanket failure).
- Anchor blanket so that continuous, firm contact (no tenting) is maintained with the soil surface.
- Check materials used for compliance with specifications and suitability for application.
- Check finished grade and dimensions for compliance with specifications.

- Check staple installation for compliance with recommendations.

Maintenance

- After storm events, check for erosion and undermining beneath blankets and confirm that run-on water is being properly managed. Rills and gullies often form from the toe of the slope and move upward. Repair as needed, by filling eroded area with soil, seeding, and replacing damaged blanket.



Figure ECB-1 Erosion Control Blanket on a Slope.

Photo courtesy of Sunshine Supplies, Inc.

Groundskeeping (GK)

Description

Activities, measures, and BMPs that are essential during construction for the protection of environmental quality.

Spill Prevention and Material Management

- All construction sites with temporary or permanent fuel storage must have a Spill Prevention Control and Countermeasures (SPCC) Plan developed by a Qualified Credentialed Professional (QCP) per 40 CFR Part 112 if the aggregate aboveground capacity is greater than 1,320 gallons.
- Verify if the SPCC plan requires secondary containment.
- Chemical storage areas must have a BMP plan that is specific for the stored chemical.
- Monitor all vehicles on-site for leaks.
- All petroleum products and chemicals must be stored in labeled tightly sealed containers. Store the containers in a neat orderly manner and under roof when possible.
- No fueling, servicing, maintenance, or repair of equipment should occur within 50 feet of a stream or within 100 feet of Public Water Supply, Outstanding Alabama Water, Outstanding National Resource Water, or a sinkhole.
- All construction traffic should use the designated construction entrance/exit.

- Mud and soil tracked onto streets and roads should be removed daily by sweeping or manual removal (DO NOT wash material into nearby storm drains).
- Concrete trucks should only be allowed to wash out at designated locations where the discharge is appropriately treated according to regulations.
- Locate portable toilets so that accidental spills will not discharge into a storm sewer or concentrated flow area.
- No hazardous materials of any kind can be disposed of on the site.
- All solid waste should be collected in a dumpster or other approved collection device and be disposed of in accordance with state law.
- Water used to pressure test sanitary sewers, flush water lines, etc., should be discharged only in approved locations. Discharge of chlorinated water may require permitting.

Spill Controls

- Materials to contain and clean-up fuel and chemical spills should be readily available on-site.
- In the event of a spill that has the potential to impact surface or groundwater, immediately call the National Response Center at 1-800-424-8802 and the Alabama Emergency Management Agency State Warning Point at 205-280-2200.
- ALL SPILLS should be cleaned up immediately, properly contained, and handled according to the Safety Data Sheet (SDS). DO NOT bury spilled materials.

Management of Hazardous Products

- Keep all products in original containers whenever possible. Make sure all containers are properly marked and labeled.
- Original labels and SDSs should be on-site until the product(s) is no longer used.
- Surplus product and empty containers should be disposed of only according to ADEM regulations.

This Page
Intentionally
Left Blank

Mulching (MU)

Description

Applying straw or other suitable materials to cover the soil surface to protect against erosion. Mulching with seeding helps establish plant cover. It can be used on unseeded areas (not concentrated flow areas) to protect against erosion until final grading and shaping can be accomplished.

Installation

- Remove stumps, roots and other debris from the site before seeding and/or mulching.
- Grade area, if needed, to permit the use of equipment for seeding, mulching and maintenance.
- Shape area so that it is relatively smooth, and that run-on water is properly managed.
- If seeding, follow seeding specifications and apply mulch immediately after seeding.
- Spread straw uniformly over the area with a power blower, hydroseeder or by hand at rates recommended for either seeded areas or without seeding. When mulching with seeding, about 25% of the ground surface should be visible after mulching is applied. When mulching without seeding, 100% of the soil surface should be covered.
- Apply mulch at the rates shown in the plan or in Table MU-1 if there is not a plan.
- Hydraulic Erosion Control Products (HECPs) as defined by the Erosion Control Technology Council (ECTC) that is used as mulch should be

applied using the manufacturer's specified rates and methods.

Table MU-1 Mulching Materials and Application Rates

Material	Rate Per Acre and (Per 1000 ft.²)	Notes
Straw (with Seed)	1 ½ - 2 tons (70 lbs – 90 lbs)	Spread by hand or machine; anchor when subject to blowing.
Straw Alone (no seed)	2 ½ - 3 tons (115 lbs - 140 lbs)	Spread by hand or machine; anchor when subject to blowing.
Wood Chips	5 - 6 tons (225 lbs - 270 lbs)	Treat with 12 lbs. nitrogen/ton.
Bark	35 cubic yards (0.8 cubic yard)	Can apply with mulch blower.
Pine Straw	1 - 2 tons (45 lbs – 90 lbs)	Spread by hand or machine; will not blow like straw.
Peanut Hulls	10 - 20 tons (450 lbs - 900 lbs)	Will wash off slopes. Treat with 12 lbs. nitrogen/ton.
HECPs	0.75 - 2.25 tons (35 lbs – 103 lbs)	Refer to ECTC or manufacturer's specifications.

Anchor straw or wood cellulose mulch by one of the following methods:

- Crimp with a mulch anchoring tool (crimper), as near to the contour as practical, to punch the straw into the soil.
- Tack with a liquid tackifier designed to hold mulch in place. Use suitable spray equipment and follow manufacturer's recommendations.
- In more erosive areas, cover mulch with netting, using a degradable natural or synthetic mesh and anchor according to manufacturer's specifications (see Erosion Control Blanket practice).
- On steep slopes and other areas needing more protection, use heavy natural nets without additional mulch, synthetic netting with additional mulch or erosion control blanket (don't place erosion control blanket over mulch). These areas include grassed waterways, swales and diversion channels.
- Install netting and blankets according to manufacturer's specifications making sure materials are properly anchored (see Erosion Control Blankets).

Maintenance

- Inspect all mulched areas periodically and after rainstorms for erosion and damage to the mulch.
- Make repairs promptly and restore to original condition.
- Continue inspections of seeded areas until vegetation is well established.
- Keep mower height high if plastic netting or blanket is used to prevent material from being entangled in mower blades.



Figure MU-1 Crimped Straw Mulch.

Permanent Seeding (PS)

Description

Establishing a permanent vegetative cover for soil stabilization and long-term erosion control by seeding disturbed areas.

Installation

- Make plantings during the specified planting period if possible.
- Spread topsoil if required (see Topsoiling practice).
- Apply lime and fertilizer according to the plans or soil test recommendations.
- If a design plan or soil test is not available, use 2 tons/acre of ground agricultural lime on clayey soils (about 90 lbs/1000 ft²) and 1 ton/acre on sandy soils (about 45 lbs/1000 ft²). For grass only, apply 8-24-24 or equivalent – 400 lbs/acre (about 9 lbs/1000 ft²) before planting and 30 lbs/acre of nitrogen fertilizer (about 0.8 lbs/1000 ft²) when vegetation has emerged to a stand. For grass-legume mixtures, apply 5-10-10 or equivalent - 800 – 1200 lbs/ac (about 18 – 27 lbs/1000 ft²) at planting. For legume alone apply 0-20-20 or equivalent – 400 – 600 lbs/acre (about 9 - 14 lbs/1000 ft²) at planting.
- On gentle slopes (3:1 and flatter) and immediately after spreading lime and fertilizer, prepare the seedbed by loosening soil surfaces to a depth of 6” to 8” with appropriate tillage equipment to incorporate lime and fertilizer.

- Grade and loosen the soil to a smooth firm surface except for no-till drilling and hydroseeding. Break up large clods and loosen compacted, hard or crusted soil surfaces with a disk, ripper, chisel, harrow or other tillage equipment.
- Avoid preparing the seedbed under excessively wet conditions.
- On slopes steeper than 3:1, lime and fertilizer may be applied to the surface without incorporation.
- Lime and fertilizer may be applied through hydroseeding equipment (usually on steep slopes). Lime may be applied with seed, but fertilizer should not be added to the seed mixture during hydroseeding because fertilizer salts may damage the seed.
- Plant the species specified. In the absence of plans and specifications, plant species and seeding rates may be selected from Figure PS-1 and Table PS-1 by qualified persons.
- Plant grasses and legume seed ¼” to ½” deep and small grains about 1” deep.
- When planting by methods other than a drill seeder or hydroseeder, cover the seed and then firm the soil lightly with a roller.
- If planting a legume, use the correct inoculant and follow recommendations on the label. For hydroseeding, increase the inoculant used to 4 times the rate recommended on the label for other seeding methods.
- Cover about 75% of the surface with the specified mulch materials. (See Mulching practice for more details).

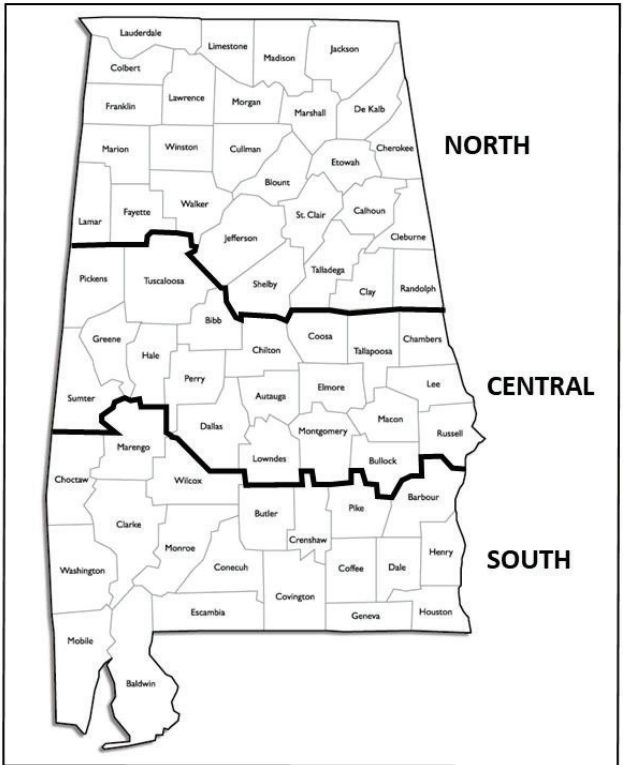

Figure PS-1 Geographical Areas for Species Adaptation

Table PS-1 Commonly used Plants for Permanent Cover with Seeding

Species	Seeding Rates/Ac PLS ^{1/}	Seeding Dates ^{2/}		
		North AL	Central AL	South AL
Bahiagrass, Pensacola	40 lbs	--	Mar 1- July 1	Feb 1- Nov 1
Bermudagrass, Common	10 lbs	Apr 1- July 1	Mar 15- July 15	Mar 1- July 15
Bahiagrass, Pensacola Bermudagrass, Common	30 lbs 5 lbs	--	Mar 1- July 1	Mar 1- July 15
Bermudagrass, Hybrid (Lawn Types)	Solid Sod	Anytime	Anytime	Anytime
Bermudagrass, Hybrid (Lawn Types)	Sprigs 1/sq ft	Mar 1- Aug 1	Mar 1- Aug 1	Feb 15 – Sep 1
Fescue, Tall	40-50 lbs	Sep 1- Nov 1	Sep 1- Nov 1	--
Sericea	40-60 lbs	Mar 15- July 15	Mar 1- July 15	Feb 15 – July 15
Sericea & Common Bermudagrass	40 lbs 10 lbs	Mar 15- July 15	Mar 1- July 15	Feb 15- July 15
Switchgrass, Alamo	4 lbs	Apr 1- Jun 15	Mar 15- Jun 15	Mar 15- Jun 15

^{1/} PLS means pure live seed and is used to adjust seeding rates. For example, to plant 10 lbs. PLS of a species with germination of 80% and purity of 90%, $PLS = 0.8 \times 0.9 = 72\%$. 10 lbs. PLS = $10 / 0.72 = 13.9$ lbs. of the species to be planted.

^{2/} Plantings made late in the listed Seeding Dates may establish slowly and fail to provide the desired cover in the year planted. Corrective actions may involve making a Temporary Seeding at the end of the first growing season and another Permanent Seeding during the following year.

Maintenance

- Generally, a stand of vegetation cannot be determined to be fully established until vegetative cover has been maintained for 1 year from planting and has reached 100% coverage and 85% density.
- Inspect seedlings weekly until a stand has germinated and, thereafter, at least monthly for stand survival and vigor.
- Bare and eroded areas should be repaired by filling and/or smoothing, and reapplication of lime, fertilizer, seed and mulch. A qualified design professional should be consulted for advice on remedial actions.
- If vegetation fails to grow, identify the cause of the failure (plant materials, lime/fertilizer quantities, poor seedbed preparation or weather) and take corrective action including having the soil tested to determine whether pH is in the correct range or a nutrient deficiency is the problem.
- Mow vegetation on structural practices such as embankments and grass-lined channels to prevent woody plants from invading.
- Other areas should be mowed to compliment the use of the site.
- Bermudagrass and bahiagrass can be mowed often and close, if so desired, during their growing season.
- Fescue should not be mowed often or closer than 4 inches during the summer. No mowing during the summer is best for erosion control.

- Sericea should not be mowed often or closer than 6 inches during the summer and should not be mowed at all during the last 6 weeks of the growing season.
- Switchgrass should not be mowed often or closer than 8 inches during the growing season.
- Control weed infestations as needed.

Sodding (SOD)

Description

Establishing vegetative cover with sod to provide immediate erosion control on bare soil.

Installation

- Begin by clearing the area of clods, rocks, etc.
- Grade and loosen the soil to a smooth firm surface.
- Loosen compacted, hard or crusted soil surfaces to 6" to 8" with appropriate tillage equipment and incorporate the lime and fertilizer.
- Where topsoiling is specified or needed, follow steps in the design plan or, if not available, apply according to the Topsoiling practice. Lime subsoil first if lime is needed.
- Apply lime and fertilizer according to the plan or by soil test recommendations. In the absence of a plan or soil test recommendations apply agricultural limestone at the rate of 2 tons per acre (90 lbs. per 1000 sq. ft.) if the pH is under 6.0 and apply 10-10-10 fertilizer at the rate of 1000 lbs. per acre (25 lbs per 1000 sq. ft.). Incorporate amendments to depth of 4" to 6".
- Rake or harrow to achieve a smooth, loose, debris-free final grade on which to lay the sod.
- Avoid preparing the seedbed when conditions are too wet.
- Use plants specified in the plan. If not specified, select a variety using Figure SOD-1 and Tables SOD-1 and SOD-2.

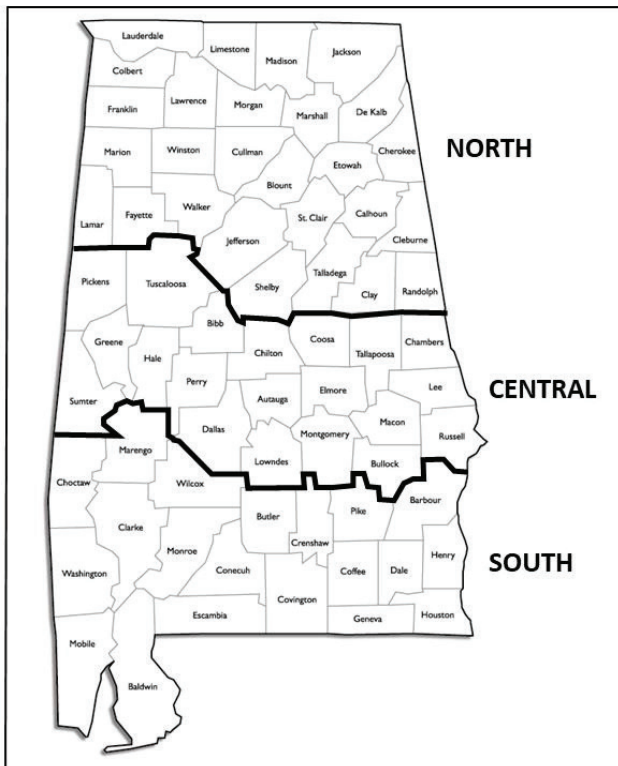

Figure SOD-1 Geographical Areas for Species Adaptation in Alabama

Table SOD-1 Grasses Adapted for Sodding in Alabama

Warm Season Species	Variety	Area Adapted
Bermudagrass	Tifway, TifSport, Celebration, TifGrand, Common	North, Central, South
Bahiagrass	Pensacola	Central, South
Centipede	Common, TifBlair	Central, South
St. Augustine	Common, and commercial varieties	South
Zoysia	Any selection available in AL, Zenith is seeded.	Central, South
Cool Season Species	Variety	Area Adapted
Tall Fescue	Kentucky 31, Rebel (turf type)	North

Table SOD-2 Adaptation and Maintenance of Grasses Used for Sodding

Species	Tolerance Ratings					Maintenance	
	Shade	Heat	Cold	Drought	Wear	Mowing Hght.	Mowing Frequency
Bermuda-grass	P	G	P	E	E	1"	H
Bahiagrass	F	G	P	E	G	2-3"	H
Centipede	F	G	P	G	P	1½"	L
Tall Fescue	G	F	G	G	G	3"	H
St. Augustine	G	G	P	P	P	2-3"	M
Zoysia	F	G	F	E	G	1"	H

E=Excellent, G=Good, F=Fair, P=Poor, H=High, M=Medium, L=Low

- During high temperatures, moisten the soil immediately prior to laying sod.
- Lay the first row of sod in a straight line with subsequent rows placed parallel to and butting tightly against each other. Stagger joints to create a brick-like pattern.
- Ensure that sod is not stretched or overlapped and that all joints are butted tight.
- Wherever concentrated flow may be a problem, install sod with the length perpendicular to the water flow (see Figure SOD-2) and secure by stapling firmly at the corners and middle of each strip. Jute or synthetic netting may be pegged over the sod for further protection during establishment.
- Immediately after laying the sod, roll or tamp it to provide firm contact between roots and soil.
- Irrigate sod deeply so that the underside of the sod pad and the soil 6" below the sod is wet.
- Until a good root system develops, water sod during dry periods as often as necessary to maintain moist soil to a depth of at least 4".

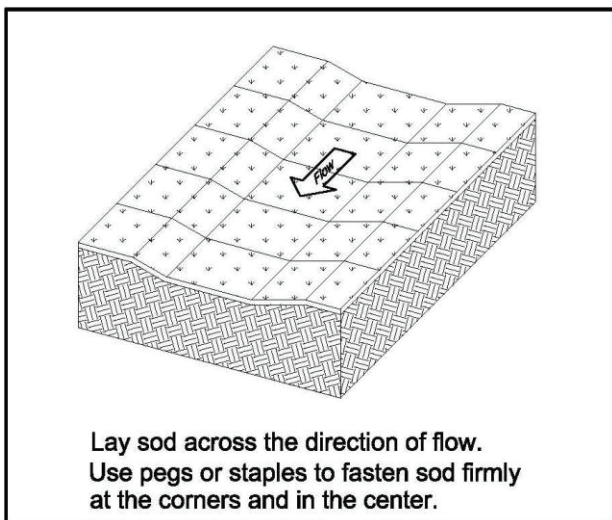

Figure SOD-2 Installation of Sod in Waterways

Maintenance

- Mow to a height of 2" to 3" after sod is rooted. Do not remove more than $\frac{1}{3}$ of the leaf blade in any mowing.
- Permanent, fine turf areas require yearly fertilization. Fertilize warm-season grass in late spring to early summer; cool-season grass in early fall and late winter.

This Page
Intentionally
Left Blank

Temporary Seeding (TS)

Description

Establishing a temporary fast-growing annual grass or legume on disturbed areas where vegetation can be established before final grading or in a season not suitable for planting the desired permanent species. Temporary seeding reduces erosion and the amount of sediment moving off the site. Apply to any portion of the site where work has temporarily ceased and will not resume for a period exceeding 13 calendar days.

Installation

- Make plantings during the specified planting period if possible.
- Loosen compacted, hard or crusted soil surfaces to a depth of 6" with appropriate tillage equipment for all methods of seeding except hydroseeding on slopes steeper than 3:1.
- Leave a smooth firm seedbed except for no-till drilling and hydroseeding.
- Avoid preparing the seedbed under excessively wet conditions.
- Incorporate lime during seedbed preparation. If a design plan or soil test is not available, use:
 - 2 tons/acre of ground agricultural lime on clayey soils (approximately 90 lbs/1000 ft²), or
 - 1 ton/acre on sandy soils (approximately 45 lbs/1000 ft²).
- Apply fertilizer during seedbed preparation. If a design plan or soil test is not available, apply

8-24-24 or equivalent – 400 lbs/acre
(approximately 9 lbs/1000 ft²) at planting.

- Apply topdressing of 30 to 40 lbs/acre of nitrogen fertilizer (approx. 0.8 lbs/1000 ft²) when vegetation has emerged to a stand.
- Incorporate lime and fertilizer to a depth of 6” with a disk or rotary tiller on slopes of up to 3:1.
- On steeper slopes, lime and fertilizer may be applied to the surface without incorporation.
- Lime and fertilizer may be applied through hydroseeding equipment. Lime may be applied with the seed mixture, but fertilizer should not be added to the seed mixture during hydroseeding because fertilizer salts may damage the seed.
- Plant the species specified. In the absence of plans and specifications, plant species and seeding rates may be selected by qualified persons using the information in Table TS-1 and Figure TS-1.
- Ryegrass is highly competitive and should not be used when a temporary cover is added to the permanent seeding mixture.
- Plant small grains about 1” deep and grasses and legume seed ¼” to ½” deep.
- When planting by methods other than a drill seeder or hydroseeder, cover the seed and then firm the soil lightly with a roller.
- If planting a legume, use the correct inoculant and follow use recommendations on the label. For hydroseeding, increase the inoculant used to 4 times the recommended rate for other seeding methods.

- Cover 75% of the surface with the specified mulch materials. (See Mulching practice for more details).

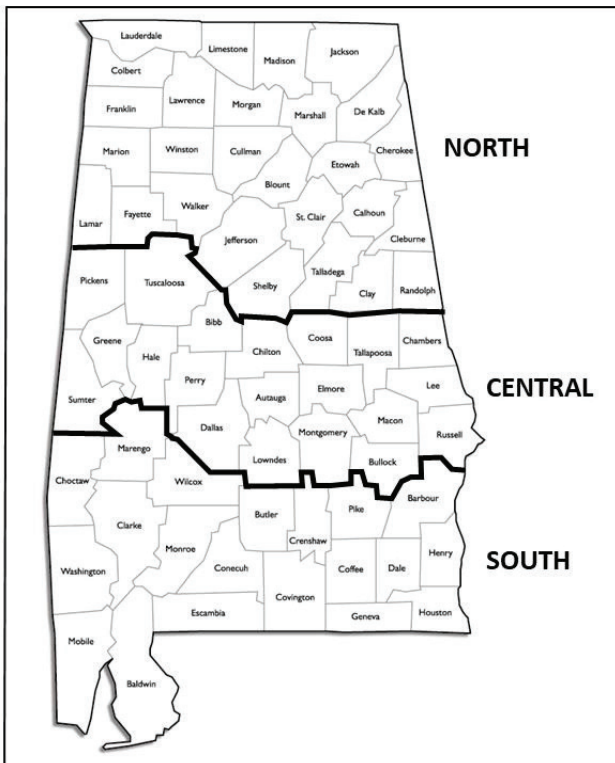

Figure TS-1 Geographical Areas for Species Adaptation in Alabama

Table TS-1 Plants for Temporary Cover

Species	Seeding Rate/Ac PLS*	North AL	Central AL	South AL	Seeding Dates				
Millet, Browntop or German	40 lbs	Apr 1- Aug 1	Apr 1- Aug 15	Apr 1- Aug 15					
Rye	3 bu	Sept 1- Nov 15	Sept 15- Nov 15	Sept 15- Nov 15					
Ryegrass	30 lbs	Aug 1- Sept 15	Sept 1- Oct 15	Sept 1- Oct 15					
Sorghum-Sudan Hybrids	40 lbs	May 1- Aug 1	Apr 15- Aug 1	Apr 1- Aug 15					
Sudangrass	40 lbs	May 1- Aug 1	Apr 15- Aug 1	Apr 1- Aug 15					
Wheat	3 bu	Sept 1- Nov 1	Sept 15- Nov 15	Sept 15- Nov 15					
Common Bermudagrass	10 lbs	Apr 1- July 1	Mar 15- July 15	Mar 1- July 15					
Crimson Clover	10 lbs	Sept 1- Nov 1	Sept 1- Nov 1	Sept 1- Nov 1					

*PLS means pure live seed. For example, to plant 10 lbs PLS with germination of 80% and purity of 90%, $PLS = 0.8 \times 0.9 = 72\%$. 10 lbs. PLS = $10/0.72 = 13.9$ lbs. of seed.

Maintenance

- Inspect seedings weekly until a stand is established and thereafter at least monthly for stand survival and vigor.
- Bare and eroded areas should be addressed appropriately by filling and/or smoothing, and reapplication of lime, fertilizer, seed and mulch. A qualified design professional should be consulted for advice on remedial actions.

- If vegetation fails to grow, identify the cause of the failure (plant materials, lime/fertilizer quantities, poor seedbed preparation or weather) and take corrective action including having the soil tested to determine whether pH is in the correct range or a nutrient deficiency is the problem.
- Millet, sorghum-sudan hybrids, sudangrass, rye and wheat may be mowed, but no lower than 6" (closer mowing may damage the stand).
- Ryegrass is tolerant of most mowing regimes and may be mowed often and as close as 4" to 6" if this regime is started before it attains tall growth (over 8").

This Page
Intentionally
Left Blank

Tree Planting On Disturbed Areas (TP)

Description

Planting desirable trees on construction sites or other disturbed areas to stabilize the soil.

Installation

- Planting should be done in accordance with the design plan. If a detailed plan is not available, obtain the assistance of a qualified professional to select long-lived and non-invasive trees that are suitable for growing on the disturbed site.
- Prepare the site for seedling type to permit adequate root development and proper tree growth.
- Bare-root seedlings should be planted between December 1 and March 15 when the soil is neither too dry nor too wet. Freezing weather should be avoided.
- Seedlings from a nursery should be kept moist and cool at all times. Do not expose seedlings to sun, wind, artificial heat, drying or freezing before they are planted.
- Balled seedlings may be kept up to 3 weeks if they are properly stacked, watered, and kept in a cool place.
- When planting is delayed longer than 3 weeks, roots should be covered with moist soil (heeled-in) or the seedlings should be put in cold storage.
- During planting, keep roots of seedlings moist.

- At the end of each day, loose seedlings should be either repacked in wet moss or heeled-in.
- If planting is being done on sloping land by equipment, the planting should be made on the contour.
- Most bare-root seedlings should be planted deeper than they grew in the nursery: small stock 1" deeper and medium to large stock ½" deeper.
- Bare root longleaf pine seedlings should be planted ¼" deeper than they grew in the nursery (never any deeper!). Containerized longleaf should be planted slightly higher than the depth grown in the nursery.
- Plant roots straight down and not twisted, balled, or U-shaped.
- Soil should be packed firmly around the planted seedlings.
- Mulching may be necessary on sloping land to reduce erosion. Mulch with wood chips, bark, pine needles, peanut hulls etc., to a depth of no more than 3". Mulch should not be placed against the trunk of the tree.
- Seedlings that are balled and burlapped or container-grown may be planted any time of the year, if watering is available during dry periods.
- Prepare hole to allow proper placement of the root ball. (See Figure TP-1).
- Depth of planting must be close to the original depth. Do not set the tree lower than it grew before.

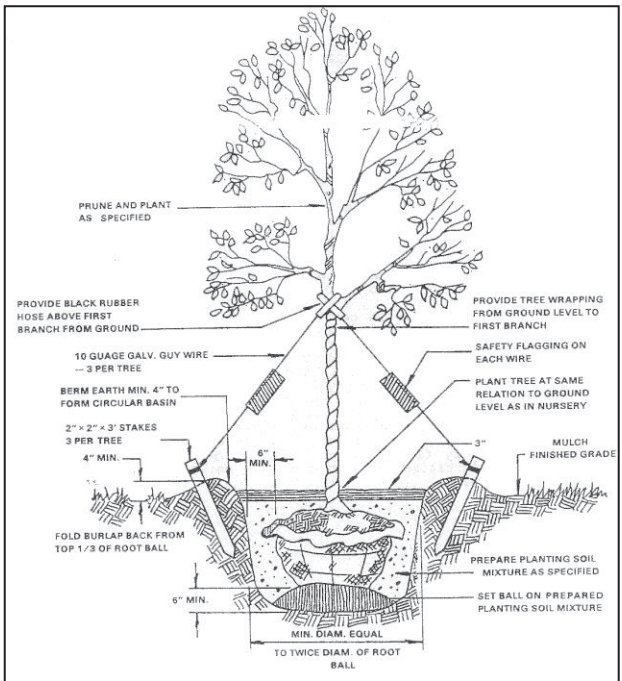

Figure TP-1 Tree Planting Diagram

- Set the tree in the hole and, if the tree is balled and burlapped, loosen the burlap and remove completely (if practical) without breaking the soil of the root ball.
- Fill the hole with soil halfway and add water to settle the soil and eliminate air pockets.
- When the water has drained off, fill the hole the remainder of the way.
- Use extra soil to form a shallow basin around the tree to help retain water.

- If needed, provide support with stakes and guy wires (see Figure TP-1). Guy wires should be loose enough to allow some movement of the tree.
- Mulch with wood chips, bark, pine needles, peanut hulls etc. to a depth of no more than 3". Mulch should not be placed against the trunk of the tree.

Maintenance

- Periodic fertilization may be beneficial on poor sites to maintain good tree growth.
- Transplanted trees should be fertilized 1 year or more after planting in the late fall or early spring before leaves emerge.
- Determine what nutrients are needed with a soil test or use 10-8-6 or 10-6-4 fertilizer in the absence of a soil test.
- About 2 lbs. of fertilizer should be used for each inch of tree diameter measured at 4.5 feet above the ground – simply broadcast it within the drip line of the tree.
- Replant dead trees where needed to maintain adequate cover for erosion control.
- Remove guy wires from a tree after the tree has developed a root system that will support the tree.

Chapter 4

Runoff Conveyance

This Page
Intentionally
Left Blank

Check Dam (CD)

Description

A small temporary dam constructed across an area of concentrated flow to pond and slow the water to reduce channel erosion. Check dams (also referred to as “ditch checks”) trap only small amounts of sediment and are not sediment control devices. Check dams are to be used on internal drainage ditches, not in “live” streams. Check dams can be constructed of rock, wattles (sometimes referred to as tubes or rolls), sand bags, silt fence, or other materials acceptable to the design professional. Since check dams are to be installed to intercept concentrated flows, proper installation is absolutely paramount for the check dam to function properly and not fail structurally.

Installation (rock check dam)

- Space the check dams so that the center of each dam is approximately the same elevation as the back toe of the upstream dam (Figure CD-2).
- Remove debris and other unsuitable material from the check dam location.
- Install an 8 oz. non-woven geotextile underlayment that extends at least 3 feet upstream and downstream beyond the rock check dam. Bury and pin the upstream edge of the geotextile and pin all edges securely with staples every 10 inches on-center.
- Ensure the proper gradation of riprap is used.
- Construct the dam with side slopes of 2:1 or flatter.

- Construct the dam with a parabolic top with the center portion 6 to 12” lower in elevation than the outer edges so that the flow goes over the structure and not around the structure.
- If specified, place geotextile on the upstream face of the dam to increase impoundment efficiency for low-flow conditions.
- Check finished size, grade and shape for compliance with standard drawings and materials list or with specifications, if included in contract specifications.
- Stabilize the disturbed area with vegetation.

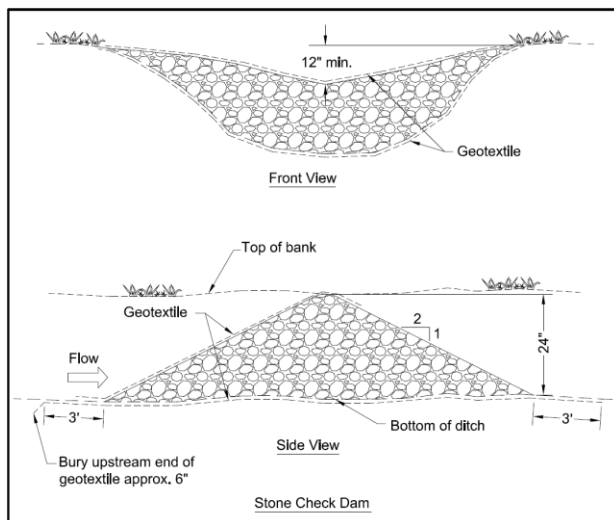

Figure CD-1 Views of a Typical Rock Check Dam

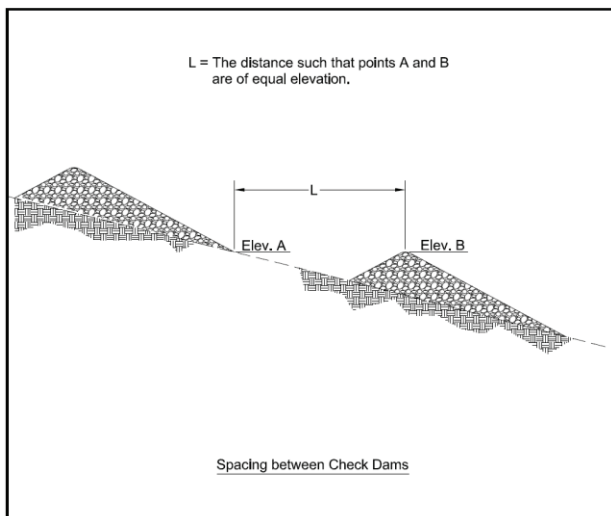

Figure CD-2 Profile of Typical Rock Check Dam

Installation (wattle check dam)

- Install an 8 oz. non-woven geotextile underlayment that extends at least 3 feet upstream and downstream beyond the wattle check dam. Bury and pin the upstream edge of the geotextile and pin all edges securely with staples every 10 inches on-center.
- Place the wattle in a “U” shape as shown in Figure CD-3.
- Staple the bottom of the wattle on 10-inch centers on each side of the wattle to keep it from floating during storm events.
- Place wooden stakes in a “t-pee” non-destructive fashion.

- If two wattles are needed to reach across the entire width of the channel, overlap the wattles at least 18 inches.

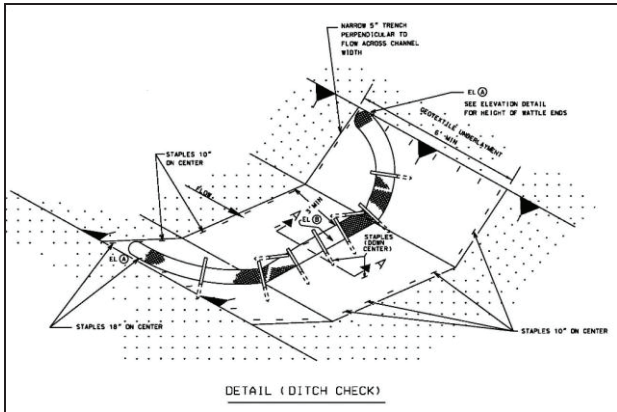

Figure CD-3 Wattle Check Dam



Figure CD-4 Wattle Check Dam

Photo courtesy of AU-ESCTF

Installation (silt fence check dam)

- Install an 8 oz. non-woven geotextile underlayment that extends at least 3 feet upstream and downstream beyond the silt fence check dam. Bury and pin the upstream edge of the geotextile and pin all edges securely with staples every 10 inches on-center.
- Install the silt fence in a “V” configuration with a notch in the fabric to ensure the maximum depth of flow is no greater than the depth of the channel.

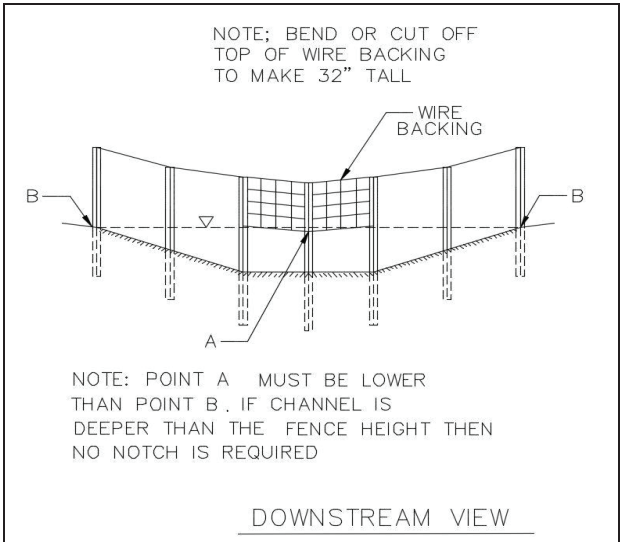

Figure CD-5 Silt Fence Check Dam Cross-Section

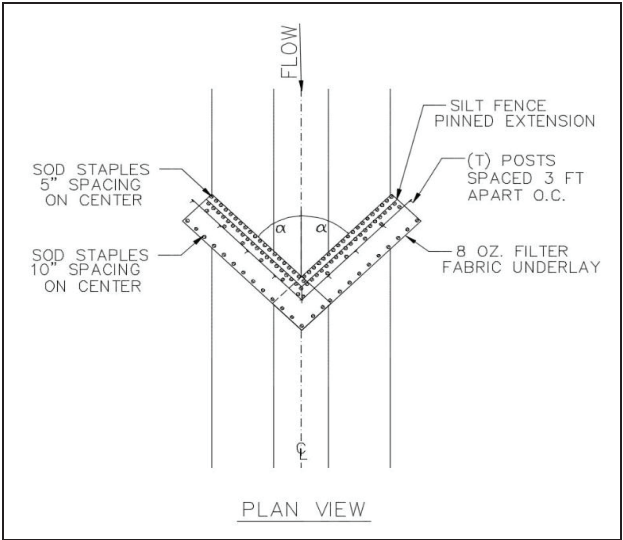

Figure CD-6 Silt Fence Check Dam Plan View



Figure CD-7 Silt Fence Check Dam

Installation (sand bag check dam)

- Install an 8 oz. non-woven geotextile underlayment that extends at least 3 feet upstream and downstream beyond the sand bag check dam. Bury and pin the upstream edge of the geotextile and pin all edges securely with staples every 10 inches on-center.
- Ensure the sand bags are properly oriented in an alternating stacking pattern.

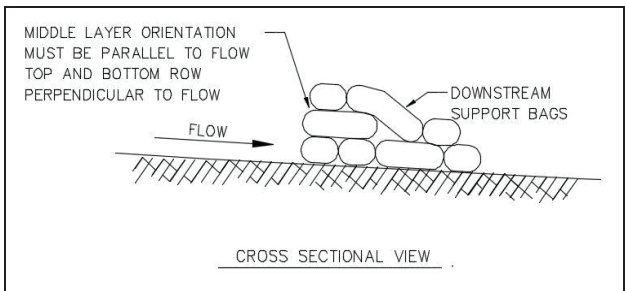

Figure CD-8 Sand Bag Check Dam Cross-Section

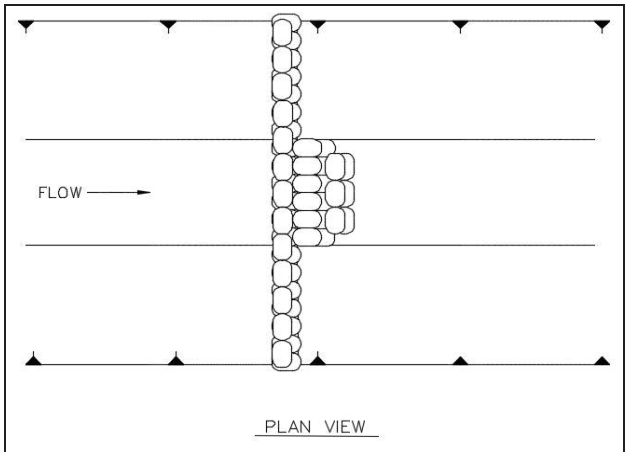

Figure CD-9 Sand Bag Check Dam Plan View

Maintenance

- After rainfall events check the practice and channel for displacement and erosion and make repairs as needed.
- If channel erosion exceeds expectations, consult with a qualified design professional.
- Remove sediment before it reaches a depth of $\frac{1}{2}$ the original dam height.
- Remove check dams when their useful life has been completed. Stabilize the area where check dams are removed with vegetation.

Diversion (DV)

Description

A temporary or permanent ridge and channel constructed on a stable grade and stabilized with vegetation. The practice is used to protect a downslope area by intercepting and carrying excess water to a stable outlet

Installation

- Begin by ensuring that the diversion outlet is stable.
- Layout the diversion from the outlet according to the design grade and planned location.
- Construct the diversion ridge by compacting earthfill in 6” to 8” lifts, overbuilding 10% for settlement.
- Check to ensure design dimensions are obtained.
- Stabilize the diversion with vegetation.

Maintenance

- Inspect after runoff events.
- Remove debris and sediment buildups in the diversion channel and repair erosion in the channel bottom.
- Rebuild the ridge to design elevation where needed.
- Check outlet for damage and repair if needed.
- Mow and fertilize vegetation.
- Remove temporary diversions after service and stabilize the area with permanent vegetation.

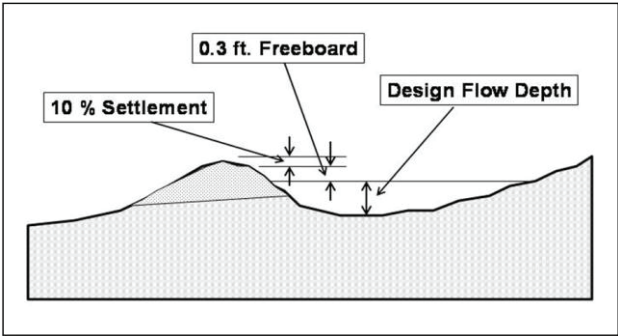

Figure DV-1 Typical Parabolic Diversion



Figure DV-2 Grassed Diversion

Grass Swale (GS)

Description

An earthen channel constructed on a stable grade and stabilized with vegetation. The practice is used to provide an area for non-erosive concentrated flow after runoff events while carrying the water to a stable outlet.

Installation

- Ensure that the grass swale outlet is stable.
- Layout the grass swale from the outlet according to the planned location and the design grade limitations.
- Ensure that lateral surface drainage into the grass swale is not blocked.
- Ensure design dimensions are obtained. Most grass swales have a parabolic cross-section but may be designed to be triangular or trapezoidal.
- Stabilize the grass swale with prescribed vegetation prior to large runoff events.
- Swales may require the use of an erosion control blanket or turf reinforcement mat to aid in establishing vegetation.

Maintenance

- Permanent water in a grass swale will destroy the vegetation and other conveyance measures may be required.
- Inspect after runoff events.

- Remove debris and sediment buildups in the swale, and repair erosion, low spots, and breaches.
- Check outlet for damage and repair if needed.
- Mow and fertilize vegetation.



Figure GS-1 Grass Swale in a Highway Median.

Lined Swale (LS)

Description

A constructed channel with a permanent lining designed to carry concentrated runoff to a stable outlet. A lined swale is used when vegetation cannot control erosion and riprap is undesirable. The lining may consist of concrete, manufactured concrete products, or turf reinforcement mat (TRM).

Installation

Concrete-lined swale is the only lined swale covered in this edition of the Field Guide. Refer to plans and specifications or manufacturer's requirements for installation of other linings.

- Layout the lined swale according to plans and as close to a linear alignment as possible.
- Prepare the location for the concrete-lined swale by removing debris and obstructions.
- Remove soft sections or unsuitable materials from foundation and replace with suitable material.
- Compact foundation soil and excavate cutoff walls to the required subgrade dimensions.
- Construct concrete forms for swale, inlet, and outlet according to plans.
- Utilize construction joints every 10 ft. and expansion joints at least every 20 ft.
- Moisten subgrade prior to concrete placement.
- Refer to plans and specifications or ACI standards for concrete placement procedures during weather extremes.

- Place concrete (minimum 3,000 psi) to thickness required on plans (minimum 4 inches) utilizing surface vibration.
- As soon as finishing work is complete, cover surface of concrete with curing compound.
- Remove forms when specified.
- Stabilize areas adjacent to lined swale with permanent vegetation.

Maintenance

- Inspect at regular intervals and after storm events.
- Check for erosion adjacent to the channel, at inlets and outlets and underneath the lined channel.
- Remove debris and sediment buildups in the swale and repair any damaged areas.

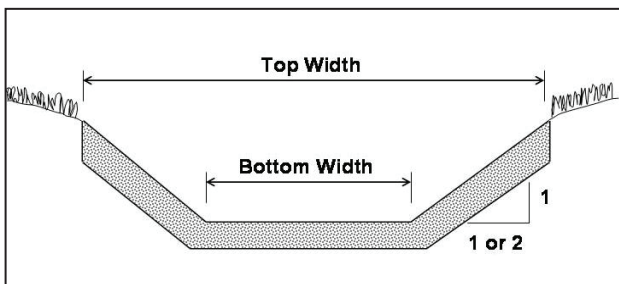

Figure LS-1 Concrete Lined Swale

Outlet Protection (OP)

Description

Measures installed to prevent erosion at the outlet of a channel or conduit by reducing the velocity and dissipating the energy. Outlet protection measures can be riprap-lined aprons, reinforced concrete flumes with concrete baffles, or reinforced concrete boxes with chambers or baffles. Some outlet protection devices are pre-manufactured.

Installation

- Prepare subgrade for structure by removing organic material and debris from work area.
- Fill low spots with clean non-organic fill, compact to density equal to surrounding material, and grade to lines and grades in plans.
- Maintain a straight alignment, if possible, or construct any curve needed in the upstream section of the structure.
- For riprap structures, install non-woven geotextile meeting specifications over the completed subgrade. Bury edges of geotextile to ensure water cannot flow under the fabric.
- Avoid damage to the geotextile when placing riprap with equipment.
- Construct the riprap apron on zero grade, with no overfall at the outlet end.
- For concrete structures, install steel reinforcement at the position shown in the plans.

- Place concrete in sturdy wood or metal forms, properly supported to prevent deformation.
- Consolidate concrete using mechanical vibrating equipment supplemented by hand-spading, rodding or tamping.
- Avoid concrete placement in inclement weather and temperature extremes. If extremes cannot be avoided, follow ACI guidelines for concrete placement in extreme temperatures.
- Cure concrete according to specifications.
- Do not remove forms prior to the specified curing time.
- Immediately after construction, stabilize disturbed area adjacent to the structure with vegetation.
- Check finished structures for conformance with designed lines, grades, and quality.

Maintenance

- After storm events, check riprap structures for erosion around and beneath the riprap and for rock displacement. Repair and replace the riprap as needed.
- Check concrete structures for structural cracks and movement. Repair as needed.
- Remove excessive vegetation, sediment, or debris.

Riprap-Lined Swale (RS)

Description

A natural or constructed channel with an erosion-resistant rock lining designed to carry concentrated runoff to a stable outlet.

Installation

- Remove brush, trees and other debris from the channel area.
- Excavate the subgrade for the riprap lining to the designed lines and grades.
- Install geotextile fabric or gravel for a filter between the subgrade and riprap. Fabric or gravel should conform to specifications.
- Place riprap to the thickness, depth and elevations shown in the design.
- Use only stone meeting the gradation and quality specified in the plan.
- Blend the finished rock surface with the surrounding ground to prevent overfalls, channel constrictions or obstructions to flow.
- Stabilize channel inlet and outlets.
- Stabilize surrounding disturbed areas using vegetation after construction is completed.
- Check finished grades and cross sections throughout channel length, verifying dimensions to avoid flow constrictions.

Maintenance

- Check channels after storm events for rock displacement, sediment accumulations, and erosion beneath the rock.
- Check for erosion at the inlet and outlet of channel.
- Check side inlets for erosion.
- Repair and replace riprap as needed.



Figure RS-1 Hand Placing Riprap.

Temporary Slope Drain (TSD)

Description

A pipe used to carry concentrated runoff water down a slope without causing erosion. The pipes are used when runoff water from an upper site needs to be temporarily conveyed down a slope before the permanent drainage structures can be installed.

Installation

- Remember that pipes are sized according to the drainage area. If not included in the plans, use the following table for pipe sizes:

Table TSD-1 Temporary Slope Drain Pipe Sizes

Maximum Drainage Area (Acres)	Pipe Diameter (D) (Inches)
0.5	12
1.5	18
2.5	21
3.5	24
5.0	30

- It is best to install the pipe before runoff water is conveyed to the pipe.
- Install the pipe with the specified watertight joints and with a flared inlet section.
- Make sure the inlet section is low enough in elevation to ensure that surface water can be directed to the inlet.

- Ensure the pipe is securely anchored to the slope according to plans or by using a “t-pee” staking.
- Extend the drain beyond the toe of the slope and adequately protect the outlet from erosion.
- Install rock or other appropriate outlet protection (see Outlet Protection Practice).
- Construct the diversion at the top of the slope according to plans so that surface runoff can be directed into the pipe. Provide positive grade in the pipe under the ridge.
- Good compaction of the diversion around the pipe is essential to avoid piping failure and blowouts.
- Establish temporary vegetation.

Maintenance

- Inspect the pipes after runoff events. Remove debris, repair erosion, and repair pipe as needed.
- Check conduit for evidence of leaks or inadequate anchoring.
- Check the outlet for erosion and sedimentation.
- Make sure that runoff is not bypassing the inlet.
- Check for evidence of overtopping, piping or uplift.
- Check for bends in conduit. Re-anchor as needed.
- Remove slope drains when they are no longer needed and stabilize the area with vegetation.

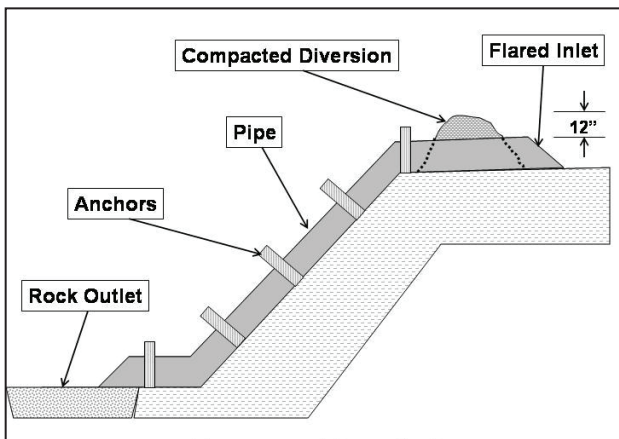

Figure TSD-1 Temporary Slope Drain

This Page
Intentionally
Left Blank

Chapter 5

Sediment Control

This Page
Intentionally
Left Blank

Brush / Fabric Barrier (BFB)

Description

A dam-like structure constructed from woody residue and faced with a non-woven geotextile fabric to provide a temporary sediment basin. This practice is applicable on sites with a small drainage area of 2 acres or less.

Installation

- Ensure the detention area for the structure is adequate.
- Smooth the foundation area for the brush/fabric barrier.
- Use woody debris from on-site to construct the barrier on a constant elevation with each end upturned to ensure that stormwater flow goes over the barrier and not around.
- Tightly pack the woody debris to form a dam that is 3 to 6 feet tall and at least 5 feet wide at the base. Align the stems with the length of the barrier.
- Trim limbs from the front side of the barrier.
- Face the front of the barrier with 8 oz. non-woven geotextile fabric utilizing the minimum pieces of fabric (one single piece is best to avoid splicing). The minimum vertical splice overlap should be 3 ft. and secured to avoid flows through the splice.
- Anchor the bottom of the fabric in an excavated trench that is at least 6" deep in front of the barrier. Stakes should be placed every 3 ft. in

the trench. Tie the top of the fabric securely with twine to stakes behind the dam.

Maintenance

- Inspect the brush/fabric barrier after rainfall events for flows around or under the structure and repair as needed.
- Remove and properly dispose of sediment before it reaches $\frac{1}{2}$ the height of the barrier.
- Check for gully erosion behind the dam after large rainfall events and repair as needed.
- Remove the brush/fabric dam when the structure is no longer needed, properly disposing of geotextile, woody debris and sediment.
- Stabilize the area with vegetation.

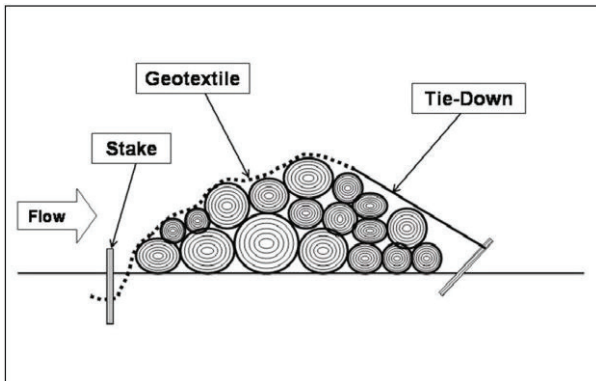

Figure BFB-1 Brush/Fabric Barrier

Flocculant (FL)

Description

A product that causes small suspended soil particles to be drawn together creating “flocs” that settle out of stormwater runoff from construction sites to help minimize turbidity.

Installation

- The application of flocculants should be designed by a qualified credentialed professional.
- The application of flocculants should conform to the design and specifications in the plans.
- Only the approved flocculants for the job can be used and only at the dosage rates and application methods approved.
- A Safety Data Sheet (SDS) for the approved flocculant should be available on the job site.
- Only mix and apply flocculants according to the Occupational Safety and Health Administration (OSHA) SDS requirements.
- Solid form flocculant (logs) should be installed at a location that maintains hydration and shade. Do not place logs in sediment, but in areas of turbulent flow.
- Dry form flocculant can be applied by hand or mechanical spreader. Small applications can be spread by hand.
- Do not apply flocculants directly to streams, wetlands, or other waters of the state.

- All runoff treated with flocculant applications must drain into a sediment basin or other BMP that promotes floc settling prior to discharge from the site.

Maintenance

- Reapply flocculants at specified intervals or when turbidity control is no longer effective.
- Inspect flocculant logs to ensure they are properly located and hydrated.
- Deposition of sediment in basins or other BMPs may require periodic sediment removal.

Inlet Protection (IP)

Description

A barrier placed around a storm drain inlet to temporarily pond runoff water, allowing suspended soil particles to settle out; thereby minimizing sediment entering storm drains during construction.

General

- Ensure that each inlet protection practice has no more than 1 acre of drainage area.
- Gentler approaches provide more storage.
- Do not use where ponding is hazardous to motorists.

Silt Fence Inlet Protection

- Once the earth surface is compacted around the inlet, place 8 oz. non-woven geotextile from the inlet to at least 1 ft. beyond the silt fence. Secure with a double, staggered row of pins on 10 in. centers.
- Place t-posts on max. 3 ft. centers around the inlet.
- Install wire backing tightly from the earth surface to top of posts and secure. Ends of wire should be overlapped 24 inches.
- Place 2 x 4 bracing on top of posts diagonally drilling holes to accommodate posts.
- Install a dewatering device.
- Install the non-woven silt fence fabric (3.5 to 4 oz.) securing tightly to fence with at least 8 in. horizontally on the earth surface. Ends of the

fabric should be overlapped 12 inches. Pin securely to earth surface on 5 in. centers.



Figure IP-1 Silt Fence Inlet Protection installation showing geotextile underlayment, steel T-posts, 2 x 4 bracing, and dewatering device.

(Photo courtesy of AU-ESCTF)



Figure IP-2 Silt Fence Inlet Protection installation showing silt fence, geotextile underlayment, steel T-posts, 2 x 4 bracing, and dewatering device.

(Photo courtesy of AU-ESCTF)

Block and Gravel Inlet Protection

- Once the earth surface is compacted around the inlet, place 8 oz. non-woven geotextile from the inlet to at least 1 ft. beyond where the aggregate will be located. Secure with two staggered rows of pins on 10 in. centers. When installing a block and gravel inlet protection on asphalt or concrete surfaces, this first layer of geotextile is not necessary
- Place a second layer of geotextile from the inlet, under the block location, with extra to extend to top of blocks.
- Place cinder blocks with at least one block turned sideways for dewatering. Place hardware cloth over the cinder block opening to use for dewatering.
- Wrap the second layer of geotextile up the face of the blocks, cut at least one opening in the geotextile for dewatering, and place a triangular cross-section of aggregate.



Figure IP-3 Block and Gravel Inlet Protection installation showing geotextile underlayment, gravel, and dewatering device.
(Photo courtesy of AU-ESCTF)



Figure IP-4 Block and Gravel Inlet Protection installation showing dewatering device.
(Photo courtesy of AU-ESCTF)

Sand Bag Inlet Protection

- Once the earth surface is compacted around the inlet, place 8 oz. non-woven geotextile from the inlet to at least 1 ft. beyond where the sand bags will be located. Secure with two staggered rows of pins on 10 in. centers.
- Leave at least 1 ft. between the bags and inlet.
- Orient the three layers of bags into a triangular cross-section with the first layer consisting of two bags oriented tangent to the circle, the second layer consisting of one bag perpendicular to the circle, and the third layer consisting of one bag tangent to the circle.



Figure IP-4 IP-5 Sand Bag Inlet Protection installation.

(Photo courtesy of AU-ESCTF)

Wattle Inlet Protection

- Once the earth surface is compacted around the inlet, place 8 oz. non-woven geotextile from the inlet to at least 1 ft. beyond where the wattle will be located. Secure with two staggered rows of pins on 10 in. centers.
- Dense wattles pond runoff better than porous wattles.
- Place the wattle in a circular fashion at least 1 ft. from the inlet. Wattle ends should be overlapped at least 18 inches and secured with grade stakes or hardwood stakes using a t-pee installation method.
- Stake the wattles with t-pee stakes at least 2 ft. on centers.
- Prevent the wattles from floating by securing with sod staples on each side of the wattle on 10 inch centers.



Figure IP-6 Wattle Inlet Protection installation.
(Photo courtesy of AU-ESCTF)

Manufactured Inlet Protection

Ensure the device:

- Is structurally supported to withstand sediment and hydrostatic loads.
- Ponds water to allow for coarse sediment to settle out of suspension.
- Does not float or undermine.
- Does not cause erosion of the soil surface between the device and the inlet.
- Has a dewatering mechanism to prevent prolonged flooding.
- Is installed according to manufacturer's specifications, ensuring adequate anchoring to ground and a good seal to prevent water from piping under the device.

Maintenance

- Inspect each inlet protection practice after rainfall events and make repairs as needed.
- Remove sediment from the pool area before its capacity is reduced by 50%.
- When the contributing drainage area has been adequately stabilized, remove all materials and sediment and dispose of properly. Fill the disturbed area to the grade of the drop inlet. Stabilize disturbed areas in accordance with the plans.

This Page
Intentionally
Left Blank

Rock Filter Dam (RD)

Description

A stone embankment constructed across natural drainageways with drainage areas of 10 acres or less used to capture sediment from disturbed areas. This practice can also be used as a forebay to a sediment basin.

Installation

- Clear and grub the area under the dam, removing roots, brush and other debris.
- Divert runoff from undisturbed areas away from the rock dam and basin.
- Smooth the dam foundation.
- If specified, cover the foundation with filter fabric, overlapping the downstream strips 1 foot with the upstream strips. Trench the upstream edge of the fabric 1 foot deep into the foundation.
- Construct the dam to the planned dimensions using rock of the specified size and quality.
- Line the face of the dam with gravel of the specified size and thickness.
- After the dam is constructed, clear the basin area.
- Set a marker at the elevation equivalent to 50% of the sediment volume to indicate the clean-out level.
- Stabilize disturbed areas within and around the rock filter dam with vegetation when construction is complete.

- Check finished grades and dimensions for compliance with specifications.
- Check materials for compliance with specifications.

Maintenance

- Check the dam after each storm event for rock displacement and erosion at the abutments and the toe of the dam. Repair and replace rock as needed.
- Remove sediment from the basin when it accumulates to the marked clean-out elevation.
- Replace gravel filter on the dam face if it becomes clogged with sediment.
- After stabilization of the construction site, remove the dam and sediment in the basin, smooth the area and stabilize using vegetation.

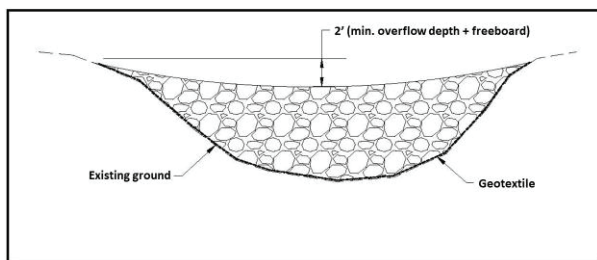

Figure RD-1 Typical Front View of Rock Filter Dam

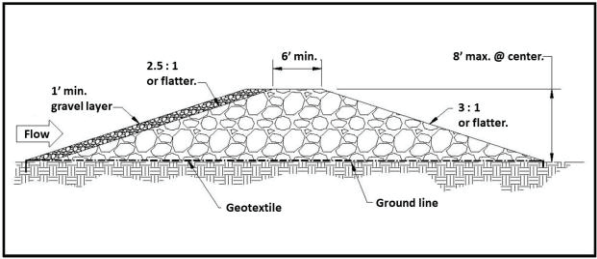

Figure RD-2 Typical Section of Rock Filter Dam



Figure RD-3 Typical Rock Filter Dam

This Page
Intentionally
Left Blank

Sediment Barrier (SB)

Description

A temporary structure across a disturbed landscape, mostly on the contour, that ponds runoff water and reduces the quantity of sediment moving downslope. Sediment barriers include silt fence, sand bags, wattles and various man-made materials. Sediment barriers are used where sheet flow can be ponded to allow sediment to settle out of the water and stay on the construction site.

Installation

Silt fence is the only barrier installation covered in this edition of the Field Guide.

- Begin by determining the exact location of underground utilities so that locations for placement of stakes can be selected where utilities will not be damaged.
- Locate the fence mostly on the contour so that sheet flow from disturbed areas must pond and pass through the fence. Turn the ends of the fence uphill to provide temporary storage of runoff and sediment.
- Generally, silt fence should not be placed across concentrated flow areas such as channels or waterways unless specifically designed by a professional and used as a check dam or inlet protection.
- Smooth the construction zone to provide a broad, nearly level area wide enough to provide storage of runoff and sediment behind the fence.

- If placed near the toe of a slope, the fence should be installed far enough from the slope toe to provide a broad flat area for adequate storage capacity for runoff and sediment.
- Dig at least a 6 in. deep and 6 in. wide trench along the fence alignment.
- Drive posts into the ground to the specified depth on the downslope side of the trench. Space posts a maximum of 10 feet if fence is supported by woven wire (Type A), or 4-6 feet when no woven wire supports the fence (Type B). At locations where runoff water may accumulate, install posts at $\frac{1}{2}$ the recommended spacing.
- Fasten support wire fence for Types A fence to the upslope side of posts and 6" into the trench.
- Attach continuous length of fabric to upslope side of fence posts. Minimize the number of joints. If joints are necessary, fasten fence securely to support posts and overlap to the next post. Avoid joints at low points along the line.
- When joining Type B fence with pre-installed posts, securely wrap the end post together with at least 2 layers of fabric prior to driving the post bundle.
- Place the bottom 12" of fabric in the 6" deep (minimum) trench, lapping toward the upslope side.
- Backfill the trench with compacted earth.
- Provide good access in areas of predicted heavy sedimentation for clean out and maintenance.
- Stabilize disturbed areas with temporary or permanent vegetation. If no vegetation plan exists, use the planting and mulching

information found in the permanent seeding, temporary seeding, or the mulching practice.

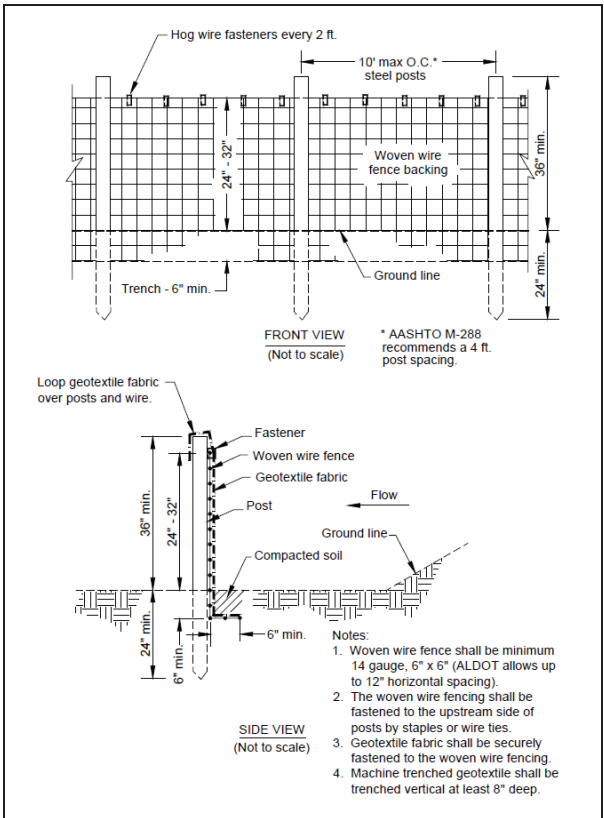

Figure SB-1 Detail of Type A Silt Fence

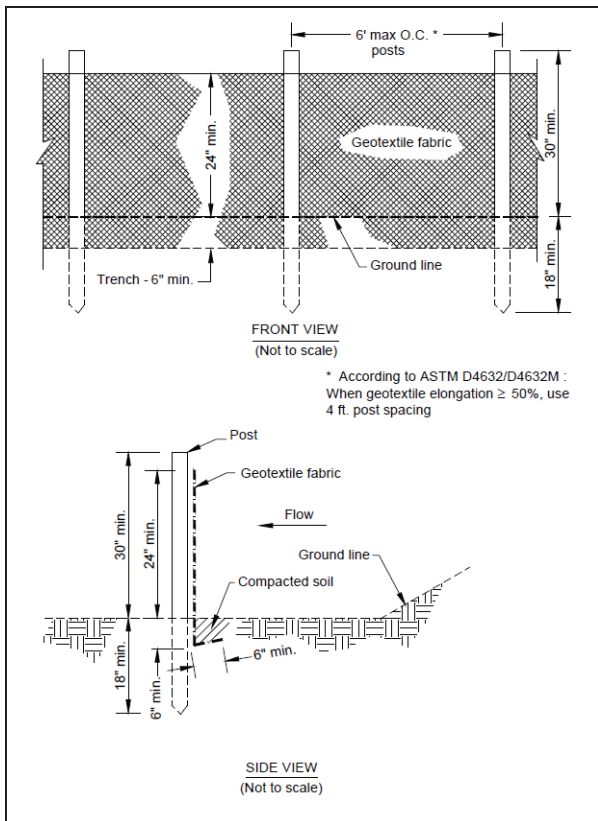

Figure SB-2 Detail of Type B Silt Fence

Maintenance

- Inspect sediment fences at least weekly and after each significant or qualifying rain event and make required repairs immediately.
- Promptly replace the silt fence fabric if it collapses, tears, decomposes or becomes ineffective.

- Remove sediment deposits before they reach a depth of $\frac{1}{2}$ the height of the fence.
- After the contributing drainage area has been stabilized, remove all barrier materials and unstable sediment deposits, bring the area to grade and stabilize it with vegetation.



Figure SB-3 Typical Type B Silt Fence Installation

This Page
Intentionally
Left Blank

Sediment Basin (SBN)

Description

An earthen embankment and/or excavation suitably located to capture runoff, with an auxiliary spillway lined to prevent spillway erosion, interior porous baffles to reduce turbulence and evenly distribute flows, and a floating skimmer or other approved surface dewatering device that removes water from the top of the basin. Flocculants are commonly used with a sediment basin to reduce turbidity and increase trapping efficiency.

Installation

- Ensure the basin and auxiliary spillway are properly located and constructed to the dimensions and other specifications on the plans.
- The storage volume at the auxiliary spillway elevation should be at least 3,600 ft³/acre of drainage area.
- The runoff water entering the basin should be at the opposite end of the basin from the discharge outlet and should enter the basin without causing erosion of the basin itself.
- All interior surfaces of the basin should be stabilized and erosion free.
- Three baffles should be installed perpendicular between the inlet and outlet of the basin creating four near equal volumes in the basin. Construct the baffles like a wire supported silt fence with 2 layers of coir erosion blanket (700 – 900 g/m²). Securely fasten the coir to the posts and

wire and pin the coir to the basin bottom (no trenching). Flow should not be allowed under, over, or around the baffles.

- A device that dewateres from the surface should be installed per the plans and manufacturer's specifications. A skimmer is often used for this purpose. Ensure that the skimmer mechanism is properly sized to achieve the basin dewatering times required. A skimmer should not be allowed to sit on the bottom of the basin. It should be slightly elevated with a gravel pad or blocks.
- Provide outlet protection at the dewatering device discharge.
- Ensure that the auxiliary spillway meets design specifications and is stabilized.
- Flocculant is often introduced into the runoff upstream of the basin in a turbulent flow area to ensure proper mixing. Ensure the flocculant is the proper material specified for the project.

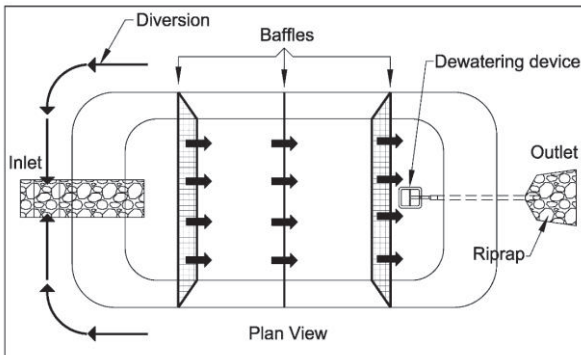

Figure SBN-1 Porous baffles in a sediment basin

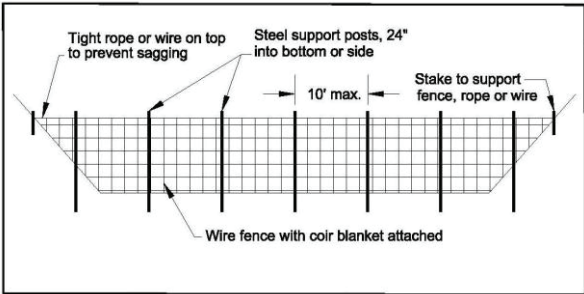

Figure SBN-2 Cross-section of a porous baffle in a sediment basin



Figure SBN-3 Example of porous baffle made of 700 g/m² coir erosion blanket as viewed from the inlet

Maintenance

- Inspect sediment basins after each storm event.
- Any erosion occurring in the interior of the basin or in the auxiliary spillway should be promptly repaired.

- Baffle displacement or water bypass of the baffles should be repaired.
- Ensure the surface dewatering mechanism is functioning properly.
- Replace flocculant when needed and per specifications.
- Remove sediment deposits promptly after it has accumulated to $\frac{1}{2}$ of the basin capacity.

Sediment Trap (ST)

Description

A temporary catch basin used on very small drainage areas to intercept sediment laden runoff and detain small amounts of sediment. Various materials may be used for sediment traps including straw bales, sand bags, wattles, and various man-made materials and devices.

Installation

Straw Bale Sediment Trap is the only Sediment Trap covered in this edition of the Field Guide.

- Smooth the construction area to provide a broad level area for bale installation.
- Excavate a trench to the dimensions shown on the drawings. Make the trench long enough to ensure end bales are upslope of the sediment pool so that excess flows do not bypass the trap.
- Place bales end to end in the trench with the bindings around the sides not top to bottom.
- Anchor the bales by driving 2 – 36 inch long 2” x 2” stakes through each bale and 18” into the ground.
- Wedge loose straw into any gaps to slow water movement through the bales.
- Backfill with compacted soil to ground level on the downstream side and 4” above ground level on the upstream side of the bales.
- Stabilize disturbed areas with vegetation.
- Check finished grade and dimensions of straw bale trap.

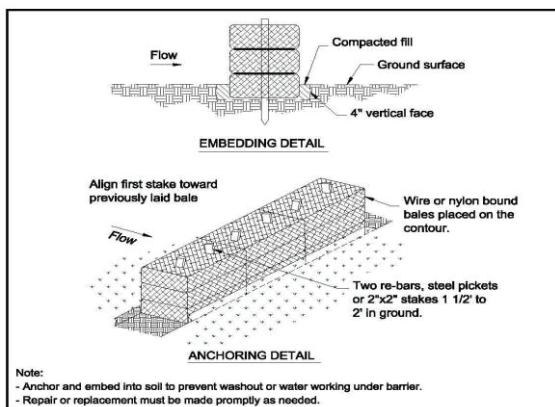

Figure ST-1 Placement of Straw Bales

Maintenance

- Inspect straw bale barriers after each storm event and remove sediment deposits promptly after it has accumulated to $\frac{1}{2}$ of the original capacity.
- Replace deteriorated and damaged bales promptly.
- After contributing area is stabilized, remove straw bales and sediment and stabilize the area using vegetation.



Figure ST-2 Straw Bales Sediment Trap

This Page
Intentionally
Left Blank

Chapter 6

Stream Protection

This Page
Intentionally
Left Blank

Temporary Stream Crossing (TSC)

Description

A bridge, culvert, or low water crossing (ford), constructed over a stream on a construction site to prevent turbidity and streambed disturbance caused by construction traffic. Stream crossings are generally applicable to flowing streams with drainage areas less than one square mile.

Installation

- Temporary stream crossings may require approvals from ADEM or the U. S. Army Corps of Engineers.
- Keep the number of stream crossings to a minimum and try to install the stream crossing during dry periods and relatively low flows.
- To minimize environmental damage, the order of preference for crossings is:
 - (1) bridge
 - (2) culvert
 - (3) ford
- Ensure that equipment used near the stream is not leaking fluids.
- Fill placed for culvert or low water crossings should be of materials that will not erode during normal or high flows.

Bridge Crossing

- Bridges are specialized engineered structures.
- Install the bridge according to plans and specifications.
- Anchor or cable the bridge so it won't be moved by a flood.

Culvert Crossing

- Ensure the culvert has a firm foundation.
- Use pipe or pipes of the size and materials specified in the plans.
- The pipe should be long enough to extend at least 2 ft. past side slopes (3:1) of the earth fill.
- Manually compact the soil around the pipe in 4" – 6" lifts.
- Extend the fill to at least 2 ft. over the pipe.
- Grade the road so that flood flows go around the crossing and not over the pipe.
- Place ALDOT Course Aggregate No. 1 stone on the road surface over the pipe.
- Place outlet protection riprap as specified or needed.
- Immediately stabilize all disturbed ground around the culvert and along the stream/conveyance.

Low Water Crossing (Ford)

- Select a location so the crossing is perpendicular to the stream flow.
- Excavate foundation according to plans to ensure the final surface is "at grade" with the stream bed (no waterfall).
- Ensure the entrance and exit slopes are gentle (5:1 or flatter).

- Place geotextile, riprap, and wearing surface as specified.
- Immediately stabilize all disturbed ground around the low water crossing and along the stream/conveyance.

Maintenance

- Always store construction materials away from the stream.
- Inspect the crossing after rainfall events and repair erosion or damage as necessary.
- Remove debris, trash, and other materials that restrict flow from the culvert or bridge.
- Because crossings are temporary structures, they are generally removed after they are no longer needed. After removal, restore the stream to its original conditions and establish permanent vegetation.

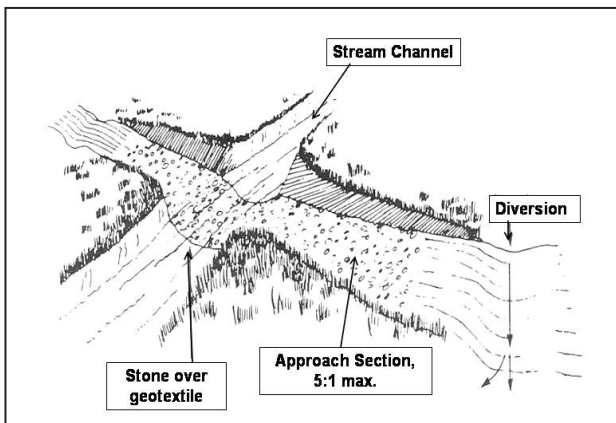

Figure TSC-1 Ford Stream Crossing

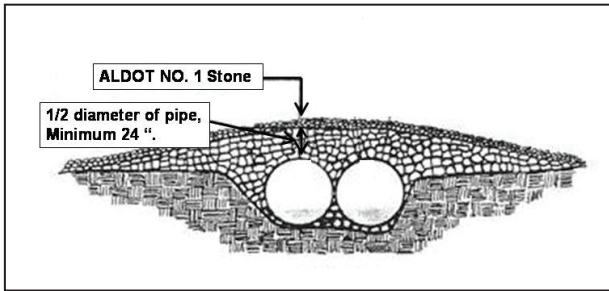

Figure TSC-2 Culvert Stream Crossing

Chapter 7

Earthen Dam Structures

This Page
Intentionally
Left Blank

Earthen Dam Structures

Drop Structure (DS)

Sediment Basin (SBN)

Stormwater Detention Basin (SDB)

Description

An earthen barrier across a drainage way usually constructed with a pipe system through the embankment and/or an auxiliary spillway bypass. Earthen dam structures may be used in conjunction with the following practices:

- Drop Structures
- Sediment Basins
- Stormwater Detention Basins

Basins created by the earthen dam can be used to convey runoff water without causing erosion, to trap sediment, and/or to reduce stormwater peak flows.

Installation

- Divert runoff from undisturbed areas away from the earthen dam practice if allowable.
- Clear and prepare the foundation for the dam by removing all objectionable material.
- Stockpile surface soil for use in top soiling and vegetation establishment.
- Excavate a keyway trench with 8 ft. bottom and 1.5:1 side slopes across the dam foundation according to the plans, at least 2 feet deep, and to an adequate foundation.

- Compact earth fill in the keyway trench with good clay material in thin lifts (6" – 9" uncompacted) back up to ground elevation.
- Install pipe system according to plans and elevations with anti-seep collars, anti-flotation block, trash rack, and outlet protection.
- Manually compact moist clayey earth fill around pipe (4"- 6" uncompacted lifts) and anti-seep collars (or drainage diaphragm) within 2 ft. of pipe and to an elevation 2 ft. over the pipe.
- Construct earthen dam in 6" – 9" uncompacted lifts (compacted to 4" - 6") to form the embankment to the planned elevation with a top width of at least 8 ft. and side slopes of 3:1 or flatter. Use most clayey material in the core of the dam with more permeable materials in the shell of the dam. Overbuild the dam at least 10% for settlement. Maintain moisture and compaction requirements according to the plans and specifications.
- Construct auxiliary spillway according to plans and elevation installing geotextile and riprap or other stabilization practices as specified.
- Make sure stormwater enters the far end of the pool to maximize trap efficiency.
- Spread stockpiled top soil and establish vegetation.

Maintenance

- Inspect the earthen dam and basin after each storm event.
- Remove and properly dispose of sediment that has accumulated to ½ the design volume.

- Remove trash from pipe system or auxiliary spillway.
- Check for any erosion, settlement, seepage, or slumping and make repairs as needed.
- If the basin is temporary, properly remove the structure and stabilize the area.



Figure EDS-1 Sediment Basin

This Page
Intentionally
Left Blank

Contacts

1. *For information regarding registration for construction sites* contact the Alabama Department of Environmental Management (ADEM) Water Division, Stormwater Management Branch (334) 271-7823, or the nearest ADEM Field Operations Division office:

Birmingham Branch

(205) 942-6168

Decatur Branch

(256) 353-1713

Mobile Branch

(251) 450-3400

Mobile Branch, Coastal Program

(251) 304-1176

Office of Field Services, Montgomery Office

(334) 394-4311

ADEM webpage: www.adem.alabama.gov

2. *If your project is within the coastal zone of Alabama* contact the ADEM Mobile Coastal Field Office for certification requirements.

3. *For information about wetland regulations or if your project could cause fill to be placed in federal waters or could interfere with navigation* contact the U. S. Army Corps of Engineers.

Mobile District

251-690-2658

Nashville District (TVA service area)

615-369-7500

Birmingham North Branch Office
205-290-9096
Montgomery Satellite Office
334-416-1769

4. *For information about the proper management/disposal of solid or hazardous waste from a construction/demolition site, contact the ADEM Land Division at (334) 271-7730.*

5. *For information on requirements for above-ground petroleum tanks and spill prevention contact the ADEM Land Division, Groundwater Branch, at (334) 270-5655 or the ADEM Field Operations Division Office listed under item #1.*

6. *To report oil or chemical spills with the potential to impact groundwater or surface waters of the State, or after becoming aware of a visible oil sheen on waters of the State, immediately call the National Response Center at 1-800-424-8802 and the Alabama Emergency Management Agency at (205) 280-2200. The caller should be prepared to report the name, address and telephone number of person reporting spill, the exact location of the spill, the company name and location, the material spilled, the estimated quantity, the source of the spill, the cause of the spill, the nearest downstream water with the potential to receive the spill, and the actions taken for containment and cleanup.*

7. *To make a complaint about pollution by sediment and other pollutants from a construction site* contact an ADEM Field Operations Division Office at the number listed under Item #1 or submit a complaint online at:

<http://app.adem.alabama.gov/complaints/submission.aspx>

8. *For information about historical or culturally significant sites* contact the Alabama Historical Commission (334) 242-3184.

9. *If conducting onsite or offsite non-coal mining or borrow operations (dirt, clay, chert, sand & gravel, etc.)* contact the ADEM Water Division, Stormwater Management Branch at (334) 271-7823. Alabama Department of Labor (ADOL) permit coverage may also be needed. Contact ADOL at (334) 242-8265.

10. If you have a question regarding fugitive dust emissions and offsite dust control related to your construction/demolition site, contact the ADEM Air Division at (334) 271-7861

11. *If your project has the potential to impact potential threatened/endangered species* contact the US Fish & Wildlife Service (USFW) at (251) 441-5181 and/or the Alabama Department of Conservation and Natural Resources (ADCNR) at (334) 242-3465.

12. *For basic information about soils* contact the local soil and water conservation district office (usually listed under county, i.e. ____ County Soil and Water Conservation District), or the Web Soil Survey,

<https://websoilsurvey.sc.egov.usda.gov/App/HomePage.htm>

13. *For additional information on seedings* contact the local Natural Resources Conservation Service or Alabama Cooperative Extension System office.

14. *For additional copies of this Field Guide* contact the local soil and water conservation district office.

15. *To view or purchase the Alabama Handbook for Erosion Control, Sediment Control and Stormwater Management on Construction Sites and Urban Areas* visit the Alabama Soil and Water Conservation Committee webpage:

<https://alconservationdistricts.gov/>

(under “Resources, Erosion and Sediment Control” tab).

17. *To view the Alabama Low Impact Development Handbook* visit the Alabama Cooperative Extension System website at:

<http://www.aces.edu/natural-resources/water-resources/watershed-planning/stormwater-management/LID.php>

Compliments of

**Alabama Soil and Water
Conservation Committee**

P.O. Box 304880

Montgomery, AL 36130-4800

<https://alconservationdistricts.gov/>

Also Providing

**Alabama Handbook for
Erosion Control, Sediment Control
and Stormwater Management on
Construction Sites and Urban Areas**



**Clear
Water
Alabama
Field Days**

ESC Seminars

Upcoming Events

[http://www.eng.auburn.edu/research/centers/auesctf/
al-stormwater/upcoming-events.html](http://www.eng.auburn.edu/research/centers/auesctf/al-stormwater/upcoming-events.html)